

## 2J0202-C366N

### 2.4/5.0 GHz ISM Connector Mount

#### Key Features

- 2.4/5.0 GHz ISM
- 2410-2490 MHz
- 4920-5925 MHz
- Connector Mount
- Ground Plane Dependent
- High Gain
- Dimensions 53 x 10 x 18 mm



## 1. Antenna and electrical specifications

Parameters	2.4/5.0 GHz ISM Antenna	
<b>Standards</b>	WiFi, BT, ZigBee, ISM	
<b>Band (MHz)</b>	2.4 Ghz	5.0 Ghz
<b>Frequency (MHz)</b>	2410-2490	4920-5925
<b>Return Loss (dB)</b>	~-14.7	~-12.8
<b>VSWR</b>	~1.4:1	~1.7:1
<b>Efficiency (%)</b>	~60	~83
<b>Peak Gain (dBi)</b>	~4.0	~5.2
<b>Average Gain (dB)</b>	~-2.2	~-0.9
<b>Impedance (Ohm)</b>	50	
<b>Polarisation</b>	Linear	
<b>Radiation Pattern</b>	Omni-Directional	
<b>Max. Input Power (W)</b>	25	
<b>Connector Type</b>	Most RF Connectors (RP-SMA-Male-RA Standard)	

### Antenna Measurement Conditions:

Mounted on Ground Plane of 70x35 mm

Measured in Certified CTIA 3D Anechoic Chamber

## 2. Mechanical and environmental specifications

Specifications	2J0202-C366N
<b>Mounting Type</b>	Connector Mount
<b>Dimensions (mm)</b>	53 × 10 × 18
<b>Radome</b>	ABS UV Stable
<b>Radome color</b>	Black
<b>Operating Temperature (C)</b>	-40 to +85
<b>Storage Temperature (C)</b>	-40 to +85
<b>Substance Compliance</b>	RoHS

### 3. Antenna parameters

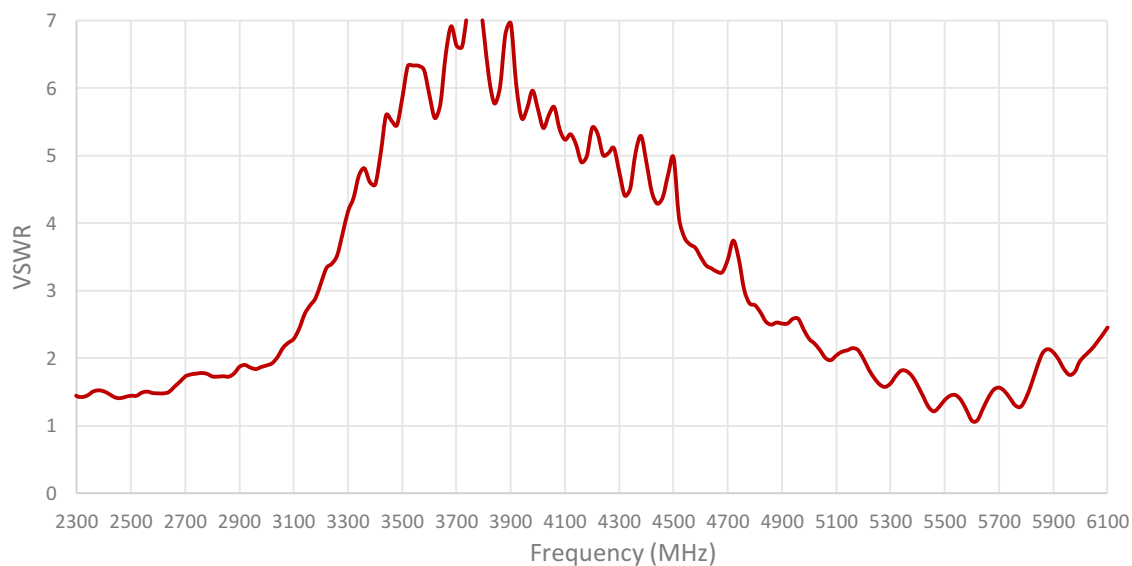
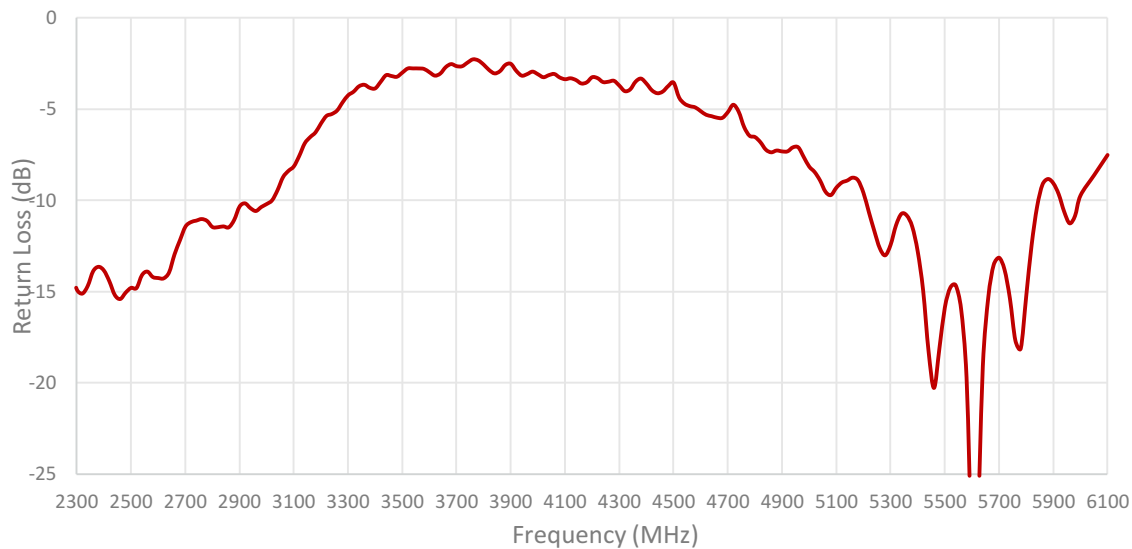

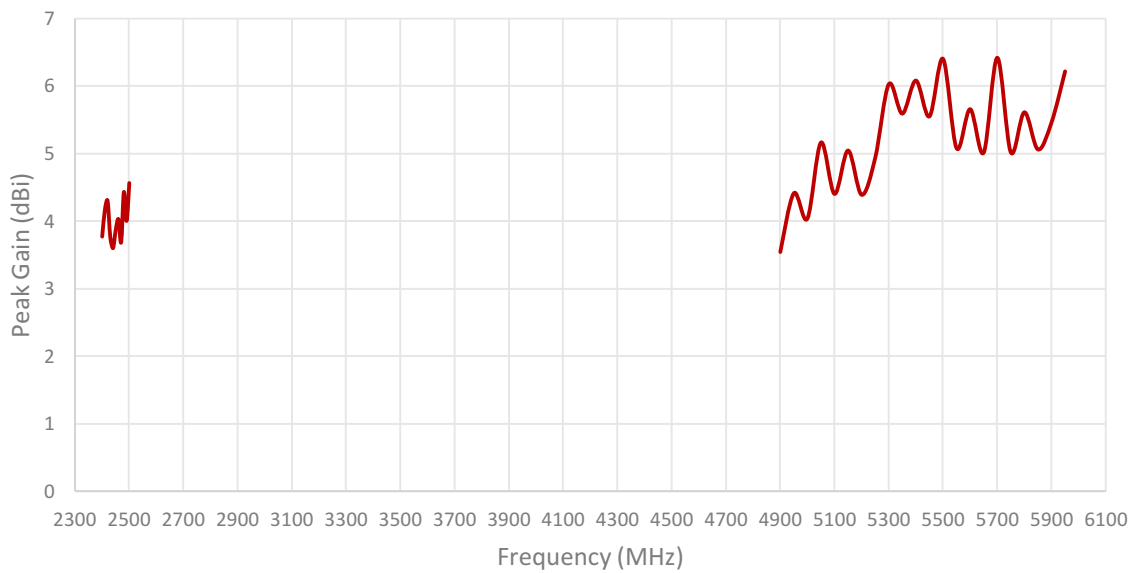
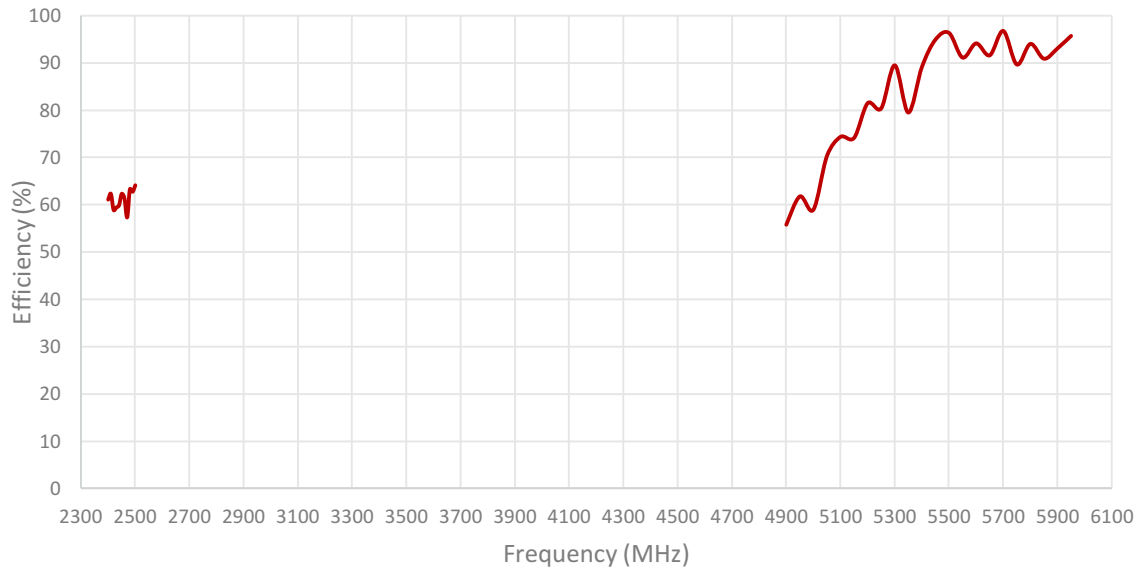

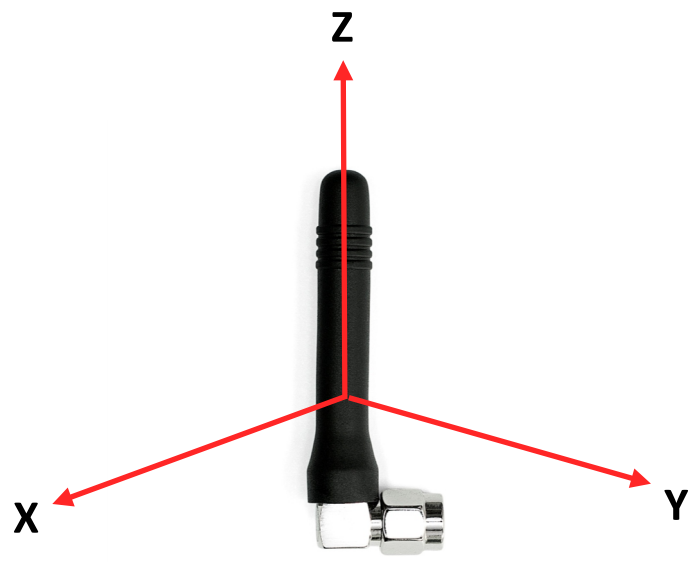
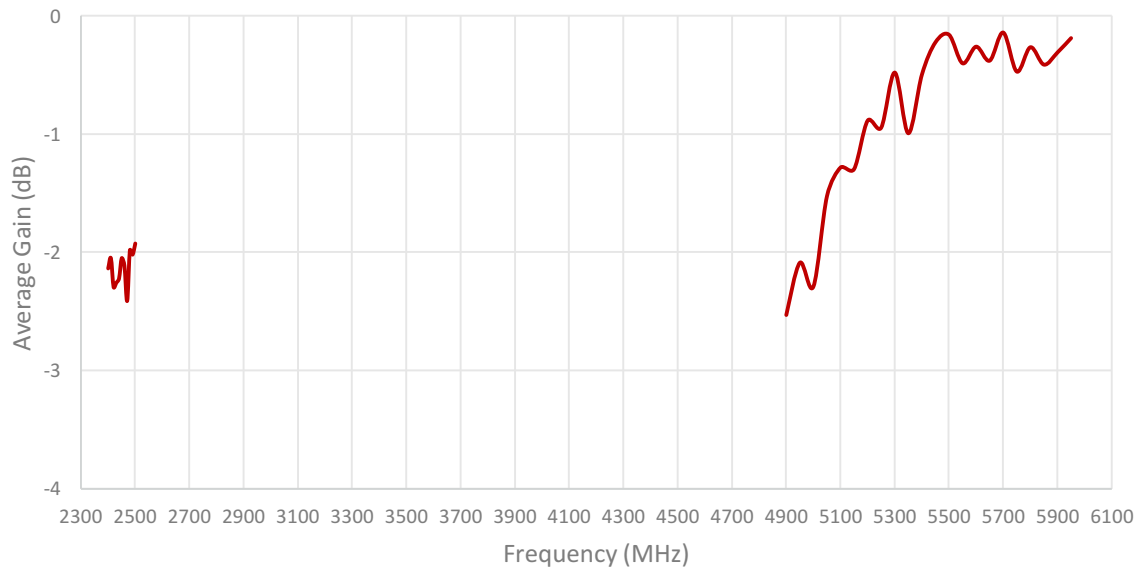

Radiation pattern reference

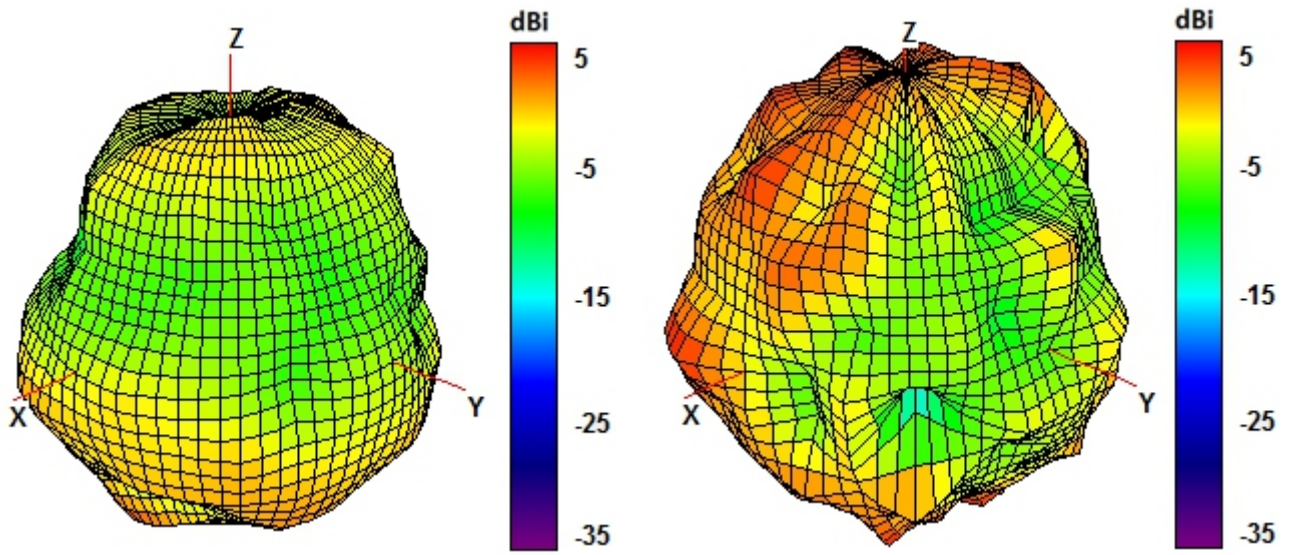

2450 and 5500 MHz Radiation pattern

## 4. Antenna drawings

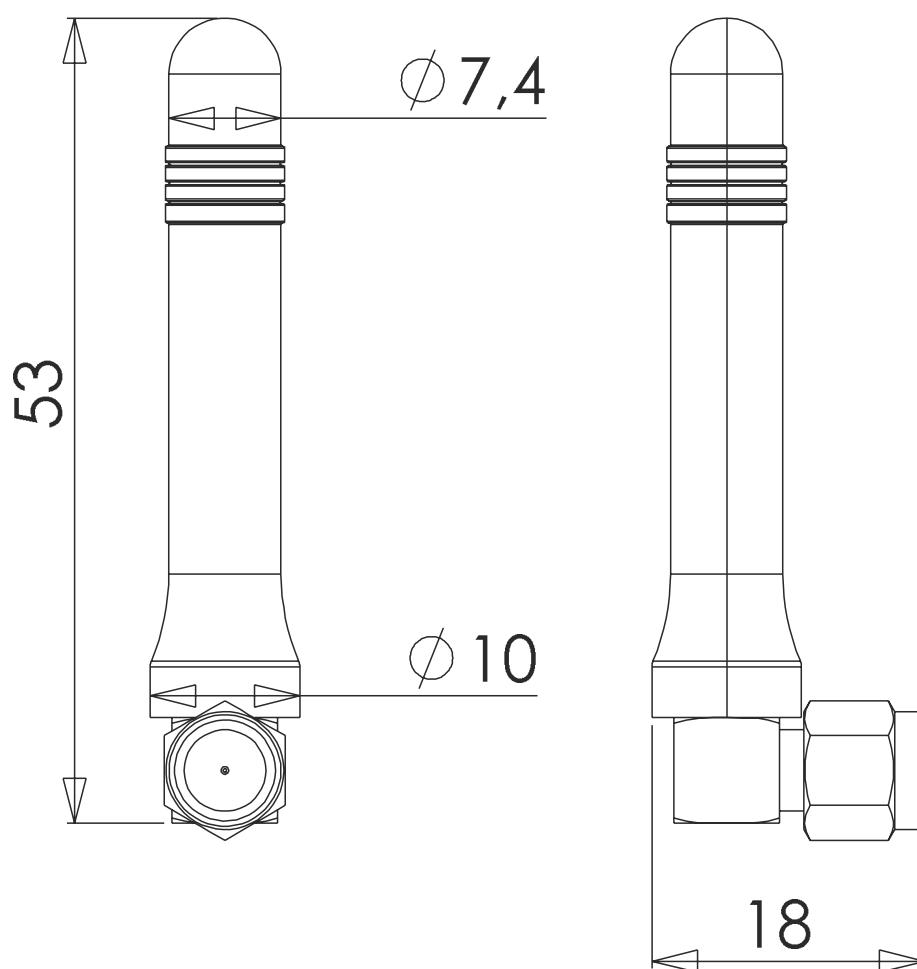

## 5. Antenna Images

